

Installation and configuration manual With Victron Energy

Pytes Lithium Battery

E-BOX series

with Victron Energy Inverter/Charger

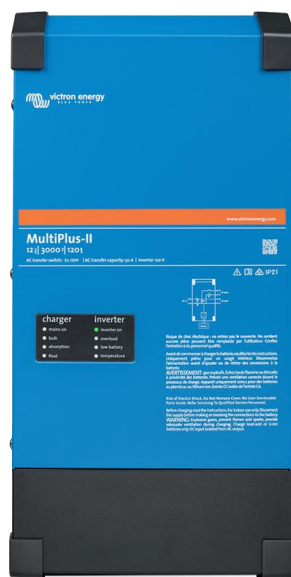

CONTENTS

Bom List.....	4
1 Power Cable Connection.....	6
Step1.....	6
Step2.....	6
Step3.....	6
2. Communication Cable Connection	7
3. Set the Dip Switch	8
4. Start up the System	8
5. CAN-bus connection Setting	8
Step1.....	9
Step2.....	9
Step3.....	10
6. Check out the Battery parameters	11
7. Check out the Inverter parameters	12
Step1.....	12
Step2.....	13

8.System Monitoring..... 14

BOM LIST

Before installation, you should prepare following items.

Item	Remarks	Quantity
Power Cable (DC)	a): Conductor cross-section: 50 mm ² to 95 mm ² b): Cable diameters: 14 mm to 25 mm c): Only copper cables may be used. d): The DC cables must be sized for the maximum battery voltage and the maximum battery current (see battery manufacturer documentation).	Depends on the number of batteries and the connection method
CAN Cable	CAN communication Terminal (RJ45 port) follow CAN protocol, to output batteries information	1
Battery	48100R / 48100C / 4850	Depends on the number of batteries and the connection method
Inverter	Victron Energy MultiPlus II	1

Definition CAN Port Pin for BMS is as follow.

Pic 1 shows the 48-50 and 48-100R(A) CAN Port definition.

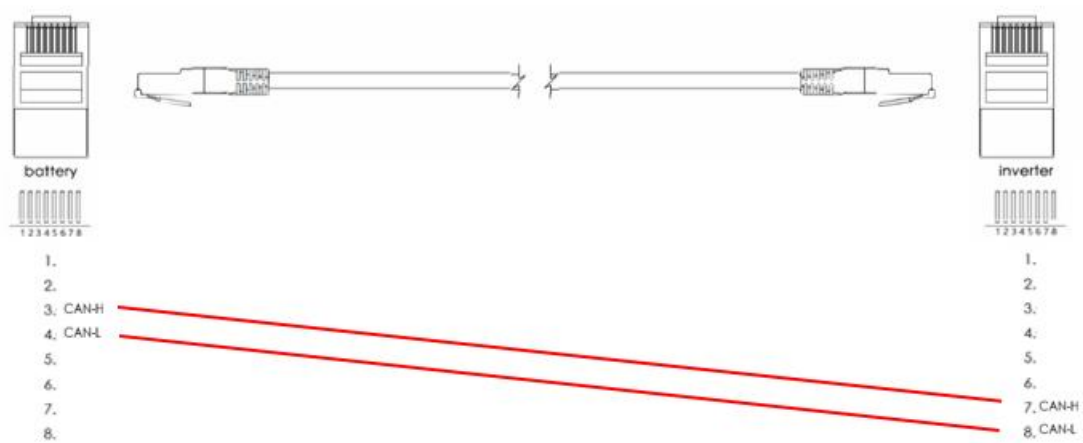

Pic 1 .CAN port definition

Pic 2 shows the 48-100R(B) CAN Port definition.

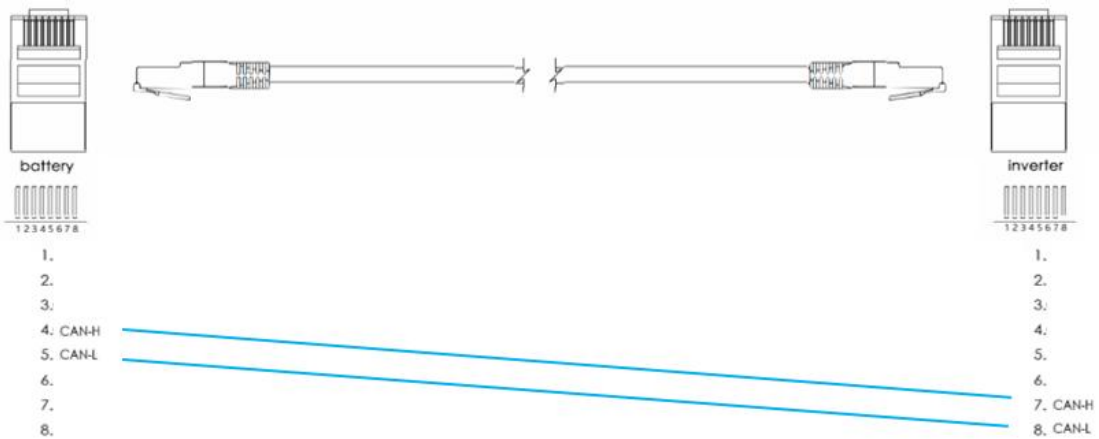

Pic2 .CAN port definition

Pic 3 shows the 48-100R(C) CAN Port definition.

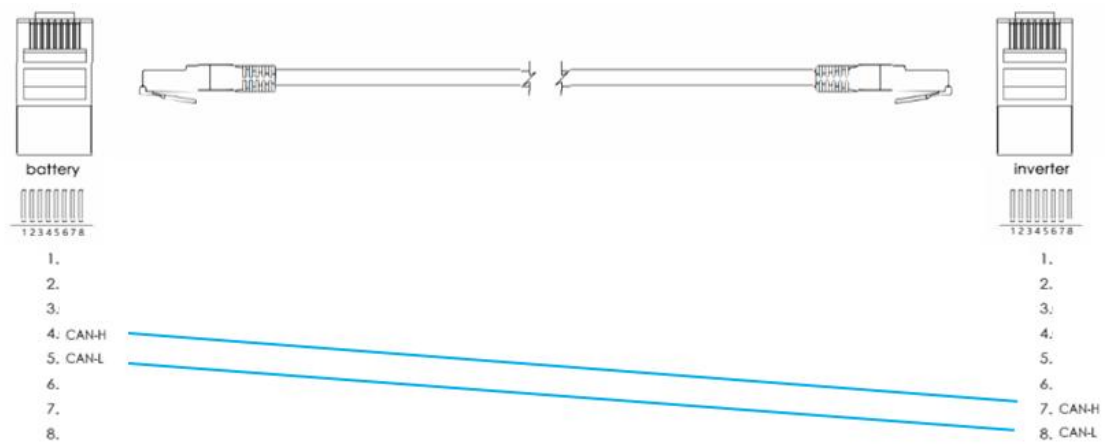

Pic3 .CAN port definition

HOW TO INSATLL

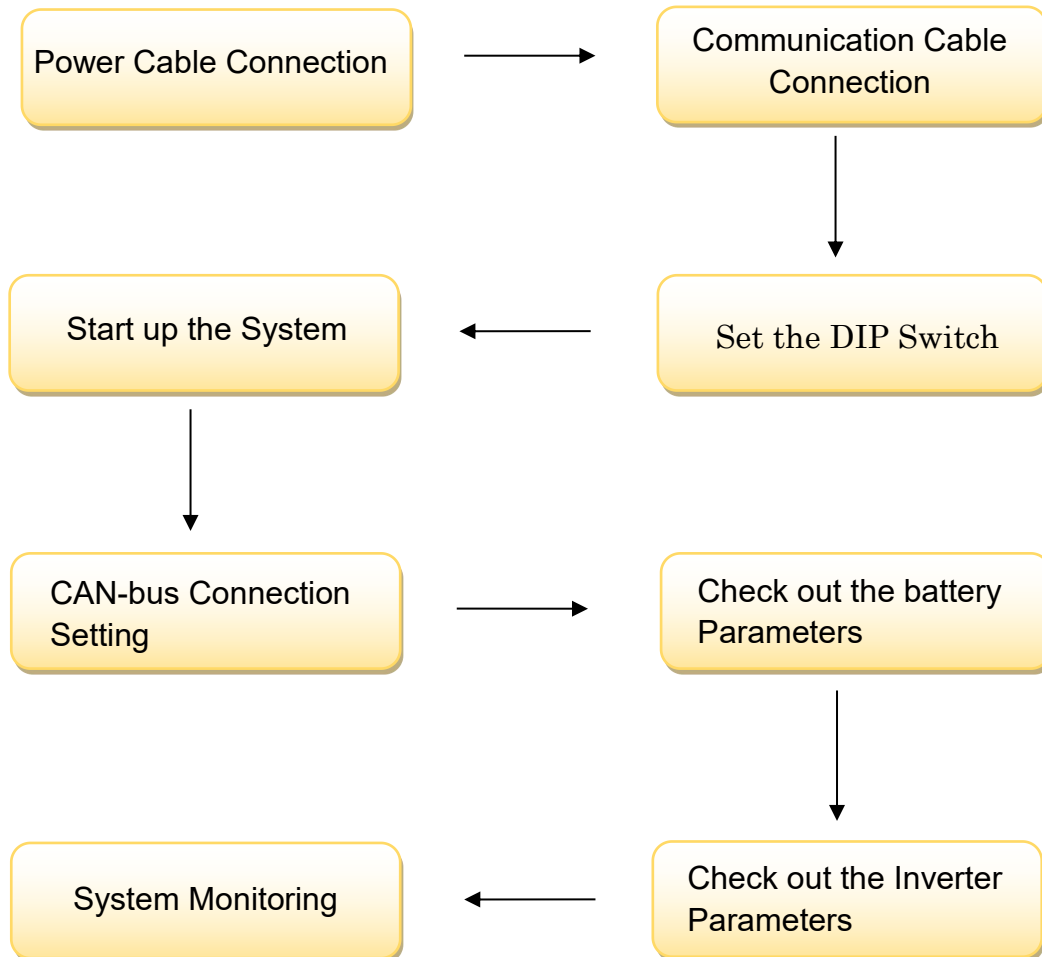

CAUTION: If you want to get more inverter-related settings, please refer to the inverter user manual first.

1. Power Cable Connection

Step.1

Open the front housing of the Victron Energy Inverter/Charger.

Step.2

Connect the red and black cables to the inverter DC connector as shown in Pic 1.1

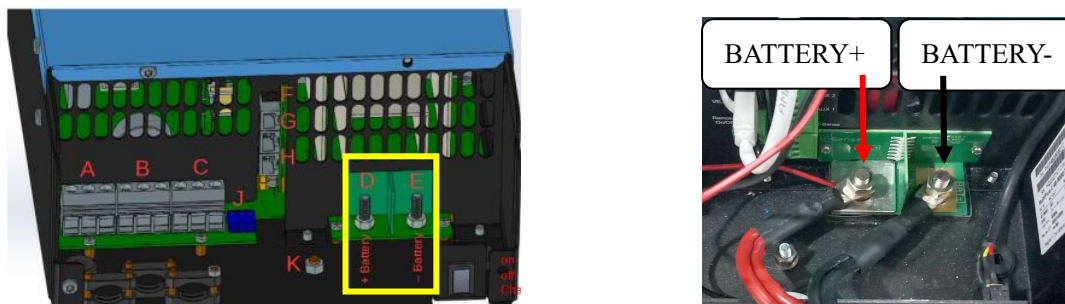

Pic 1.1

Step.3

At the other end of the cable, connect to the battery as shown Pic 1.2
(Ensure that the battery power switch is off)



Pic 1.2

2. Communication Cable Connection

Insert inverter end of the CAN cable into the controller at VE.Can.
 Insert battery end of the CAN cable into the battery at CAN. (Ensure the correct sequence of wires inside the CAN cable).

Insert VE.Bus cable two ends respectively into the inverter and the controller. as shown in pic 2.1.

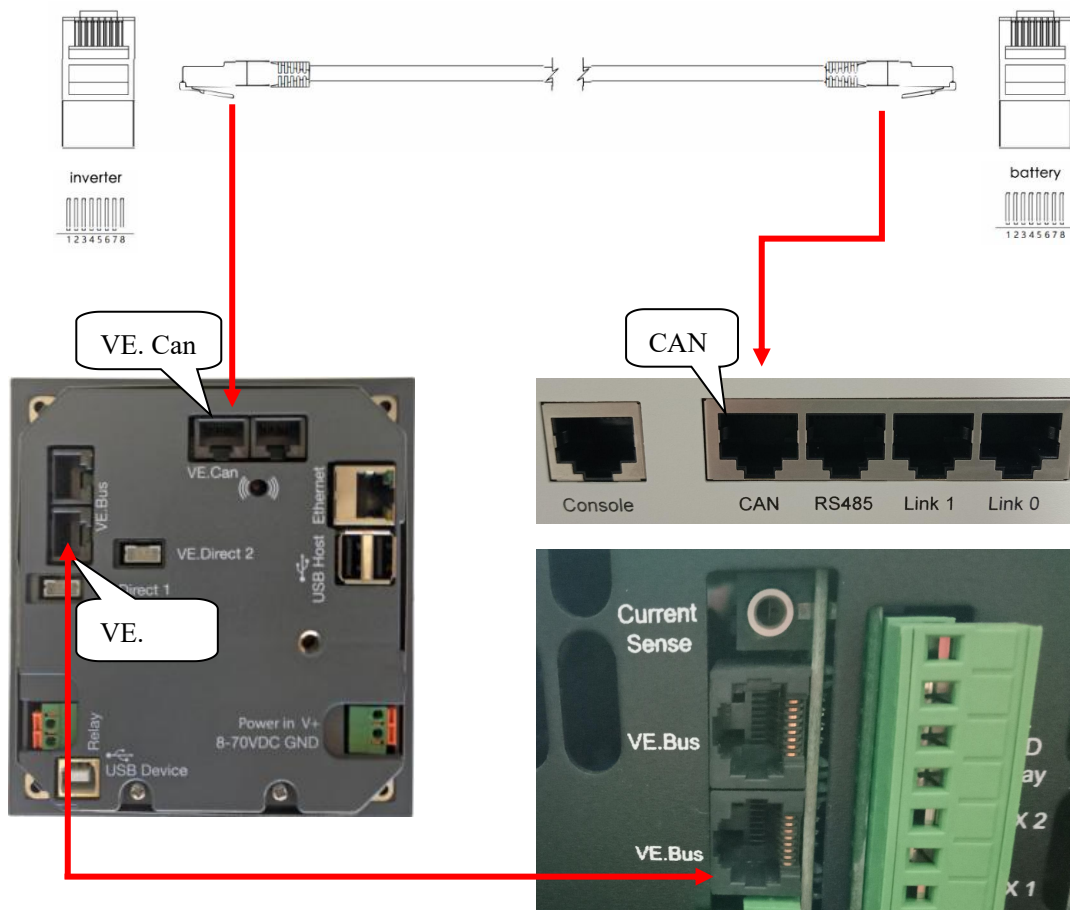

Pic 2.1

3. Set the DIP Switch

For A and B version, set the DIP switch as shown in 3.1 and figure 1.



Pic 3.1

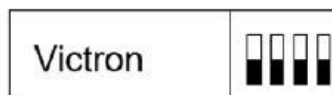

figure 1

For C version, set the DIP switch as shown in 3.2 and figure 2.



Pic 3.1

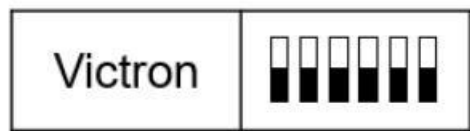
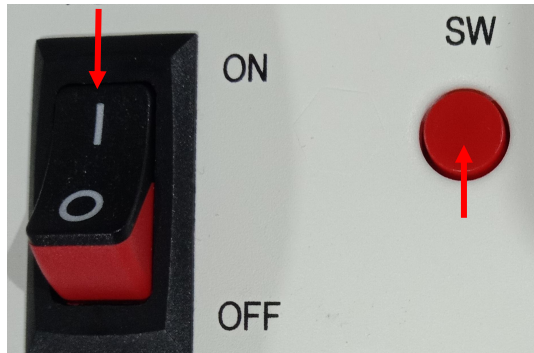

figure 2

4. Start up the System

Start up the battery.

Firstly, press the power button on, next press the SW red ring button as shown in pic 4.1.



Pic 4.1

5.CAN-bus connection Setting

※**CAUTION:** If you want more details about the batteries settings , please check the operating manual of battery.

Step1.

Check the inverter indicator on and the controller screen lights on as shown in pic 5.1.1 and 5.1.2.

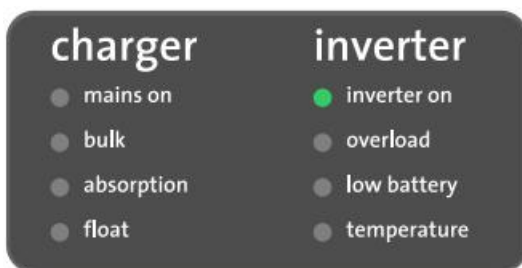

Pic 5.1.1



Pic 5.1.2

Step2.

Firstly, press Settings and down to the Services at the bottom line as shown in 5.2.1.and 5.2.2.

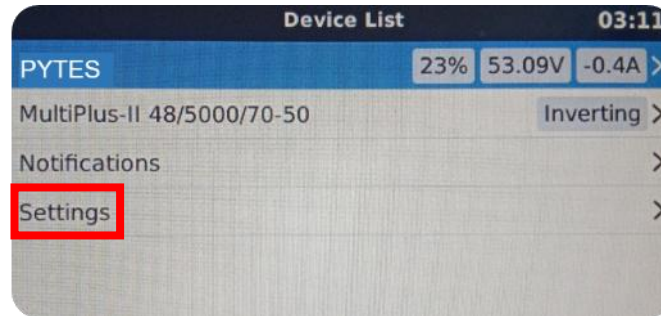

Pic 5.2.1

Next, choose the CAN-bus line as shown in 5.2.3.

Then, choose the CAN-bus BMS (500kbit/s) as shown in 5.2.4.

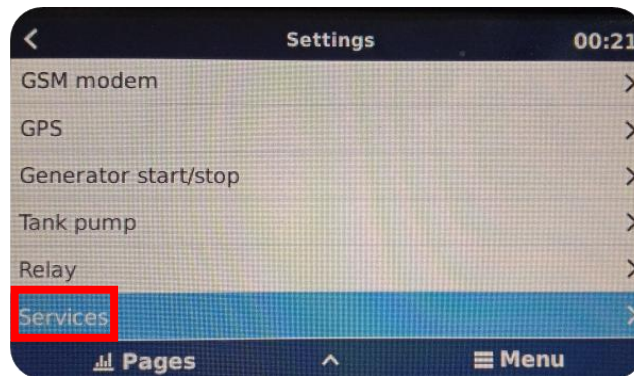

Pic 5.2.2

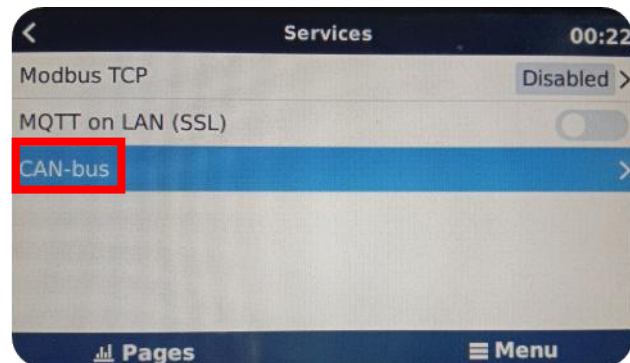

Pic 5.2.3

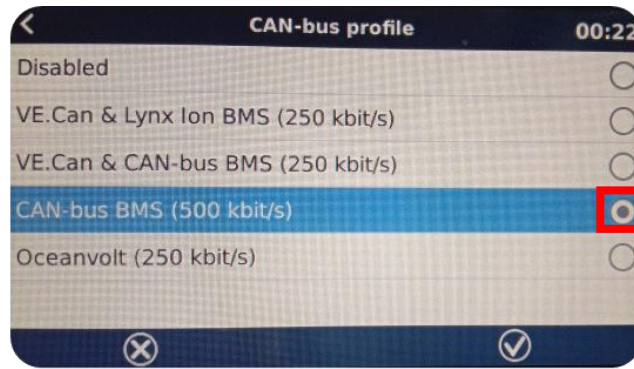

Pic 5.2.4

Step3.

Check device connection as shown in pic 5.3.1, 5.3.2.and 5.3.3.

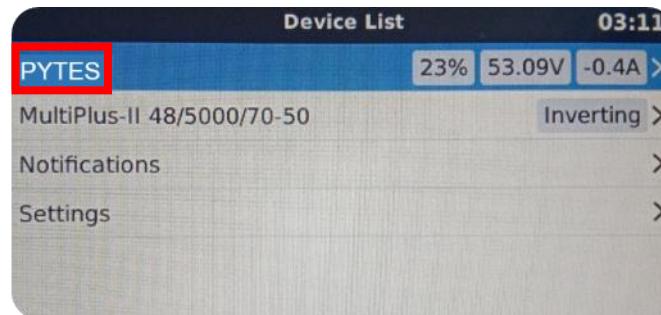

Pic 5.3.1

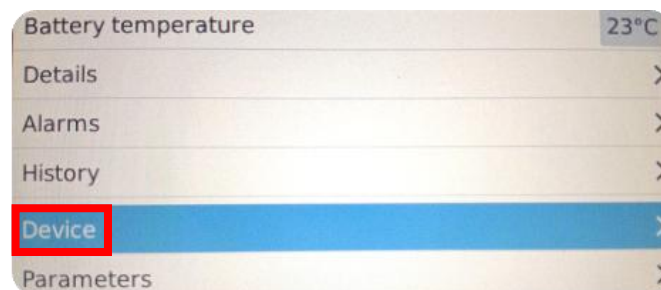

Pic 5.3.2

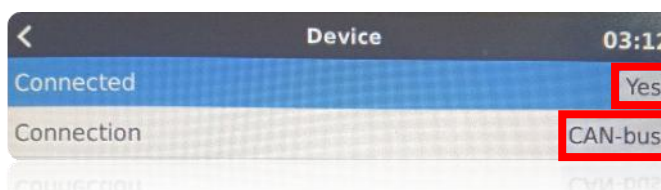

Pic 5.3.3

6. Check out the Battery Parameters

Firstly, check the battery basic parameters: SOC, Voltage and Current on the PYTES line as shown in pic 6.1.

Next, go into PYTES, check more battery details, as shown in 6.2 and 6.3.

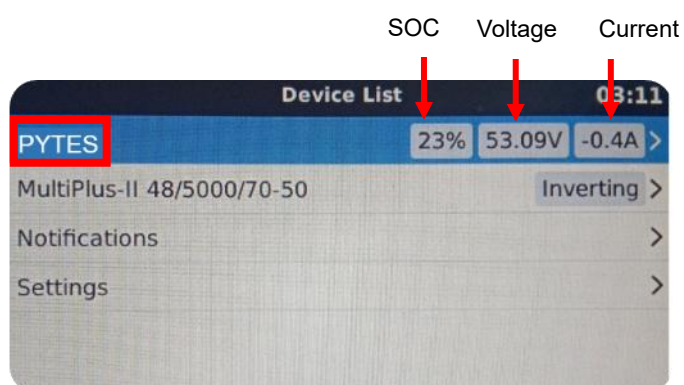

Pic 6.1

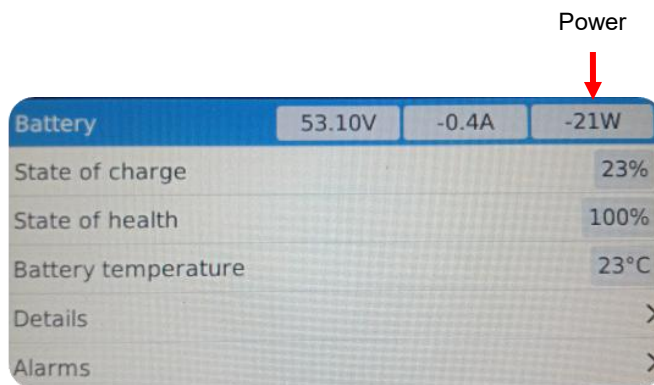

Pic 6.2

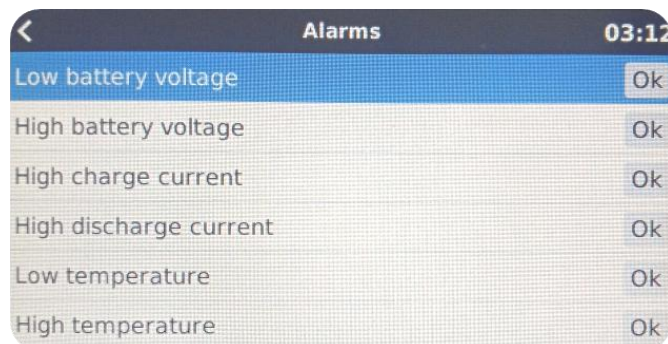

Pic 6.3

7. Check out the Inverter Parameters

Step.1

Enter MultiPlus-II 48/5000/70-50 as shown in pic 7.1.1.

Check out the inverter Switch, AC output as shown in pic 7.1.2 and 7.1.3.

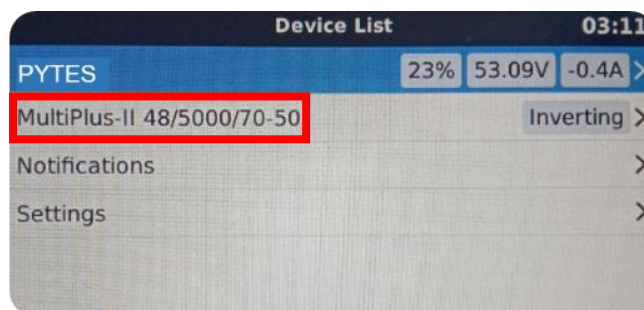

Pic 7.1.1

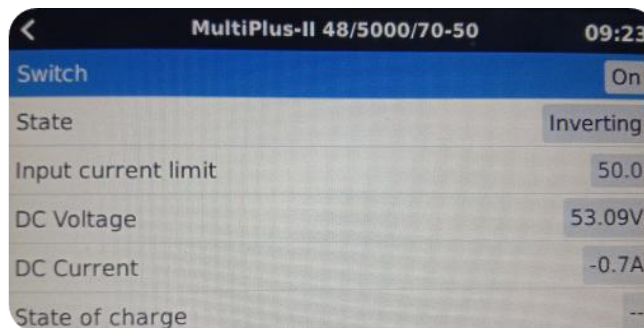

Pic 7.1.2

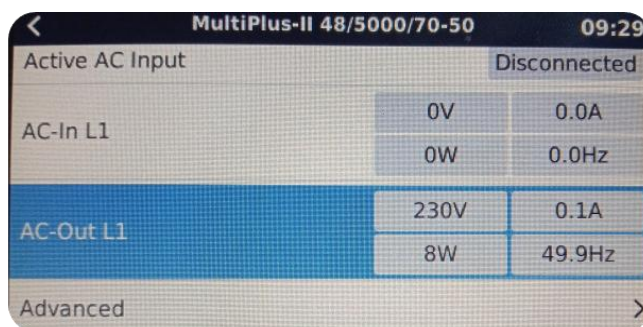

Pic 7.1.3

Step.2

Check the device connection as shown in pic from 7.2.1.and 7.2.2.

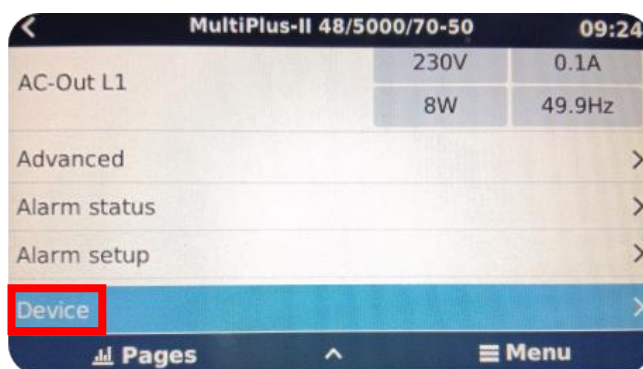

Pic 7.2.1

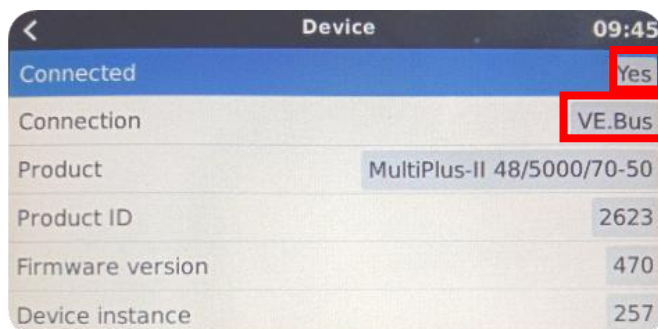

Pic7.2.2

8.System Monitoring

※ CAUTION: If you want more details about system monitoring ,

please check the operating manual of inverters.